

Data Sheet



Article number: 12621000140000

Description: Industrial tool 621 000 140.000
For M14

Measures

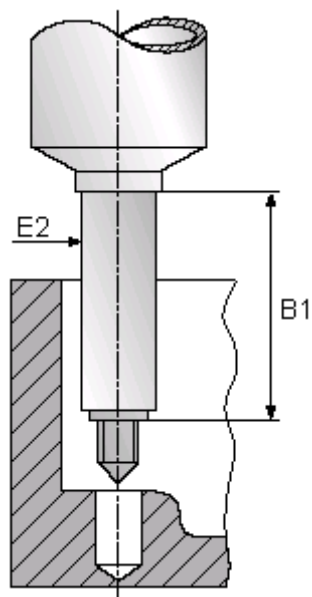

B1	= 60
E2	= 20
For thread	= M14